

BLDG. SIZE: 30 x 50 x 14
(1:12 PITCH)

AB1 of 1 — Anchor Bolt Plan
F1 of 1 — Foundation Plan
1 of 3 — Roof Framing Plan
2 of 3 — Sidewall Framing Elev.
3 of 3 — Endwall & Rigid Framing Elev.
SH1 of 3 — Roof Sheeting Plan
SH2 of 3 — Sidewall Sheeting Elev.
SH3 of 3 — Endwall Sheeting Elev.

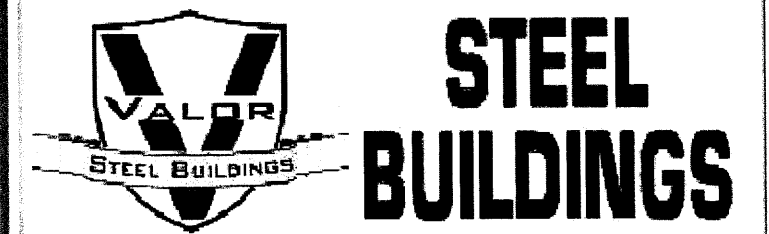

590 US HWY 98
SUITE 3
DAPHNE, AL 36526
LOCAL (251) 379-8042
TOLL FREE (855) 55-VALOR
www.valorsteelbuildings.com

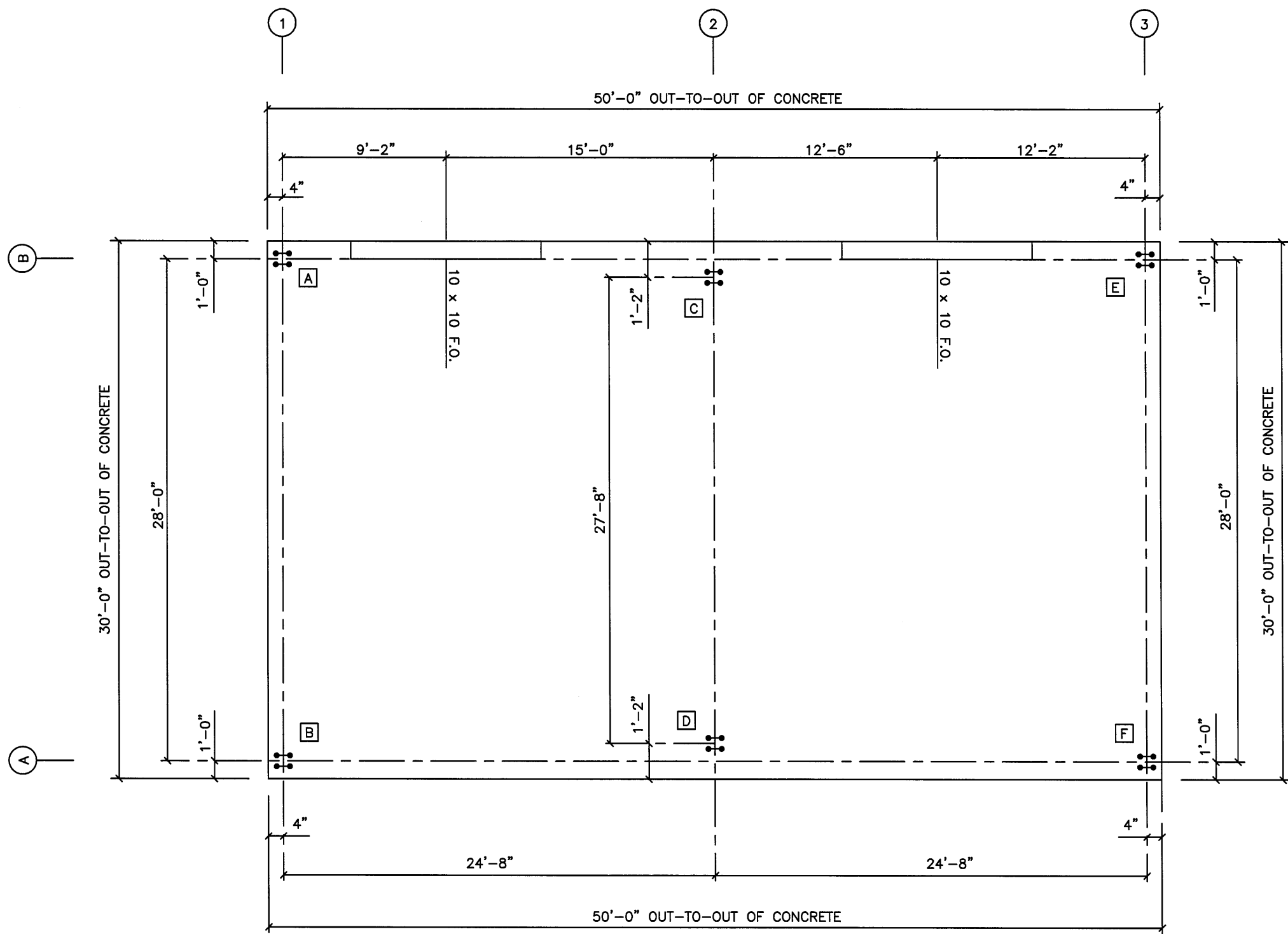

ANCHOR BOLT PLAN
N.T.S.



VALOR STEEL BUILDINGS
590 US HWY 98 - SUITE 3
DAPHNE, AL 36526
LOCAL (251) 379-8042
TOLL FREE (855) 55-VALOR
www.valorsteelbuildings.com

Bldg. Size: 30 x 50 x 14

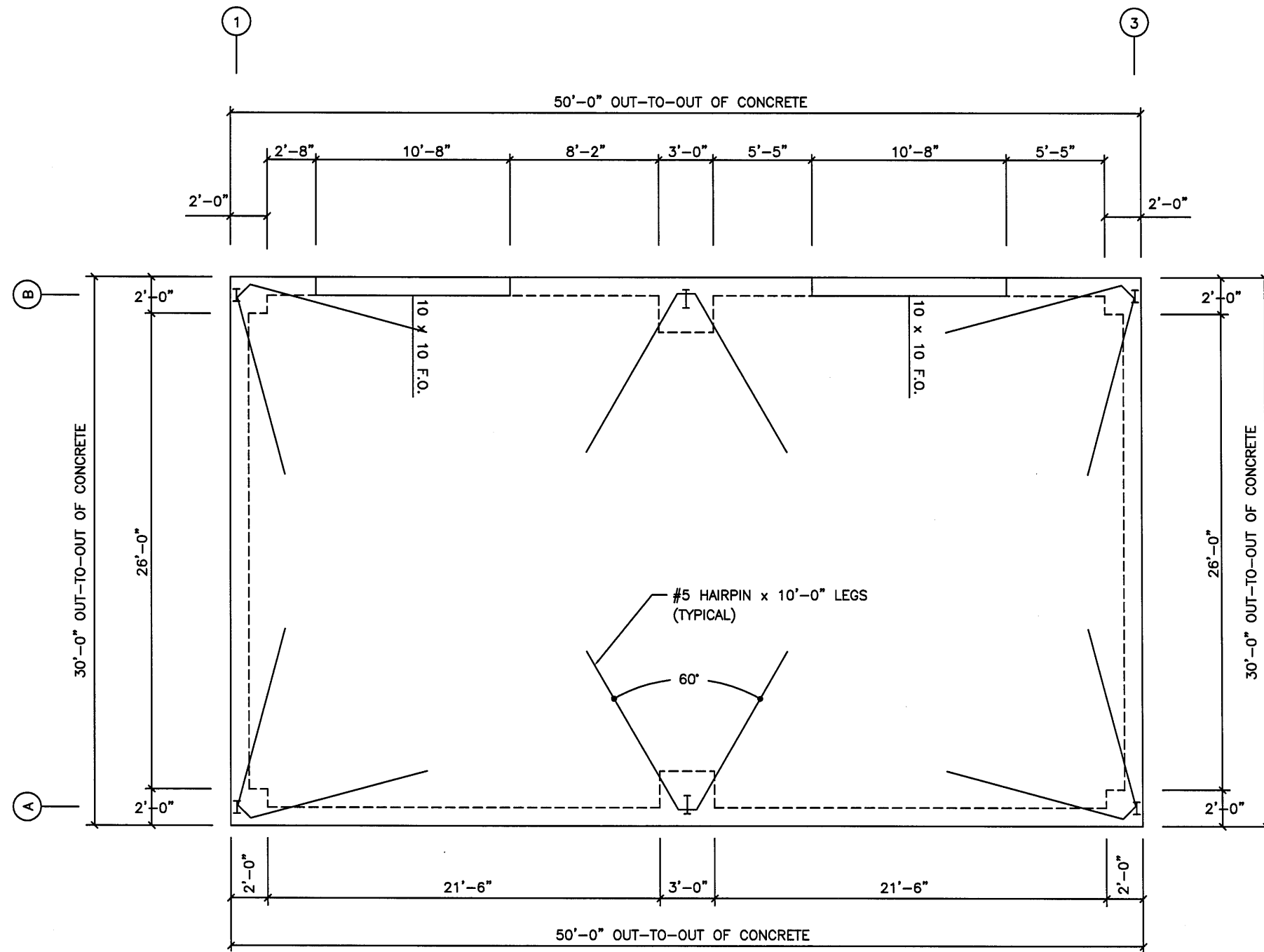

FOUNDATION PLAN
N.T.S

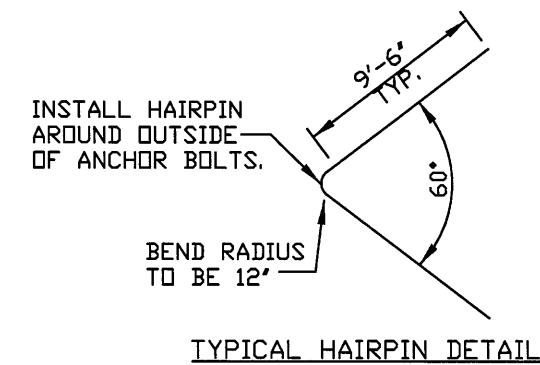

VALOR STEEL BUILDINGS
590 US HWY 98 - SUITE 3
DAPHNE, AL 36526
LOCAL (251) 379-8042
TOLL FREE (855) 55-VALOR
www.valorsteelbuildings.com

Bldg. Size: 30 x 50 x 14

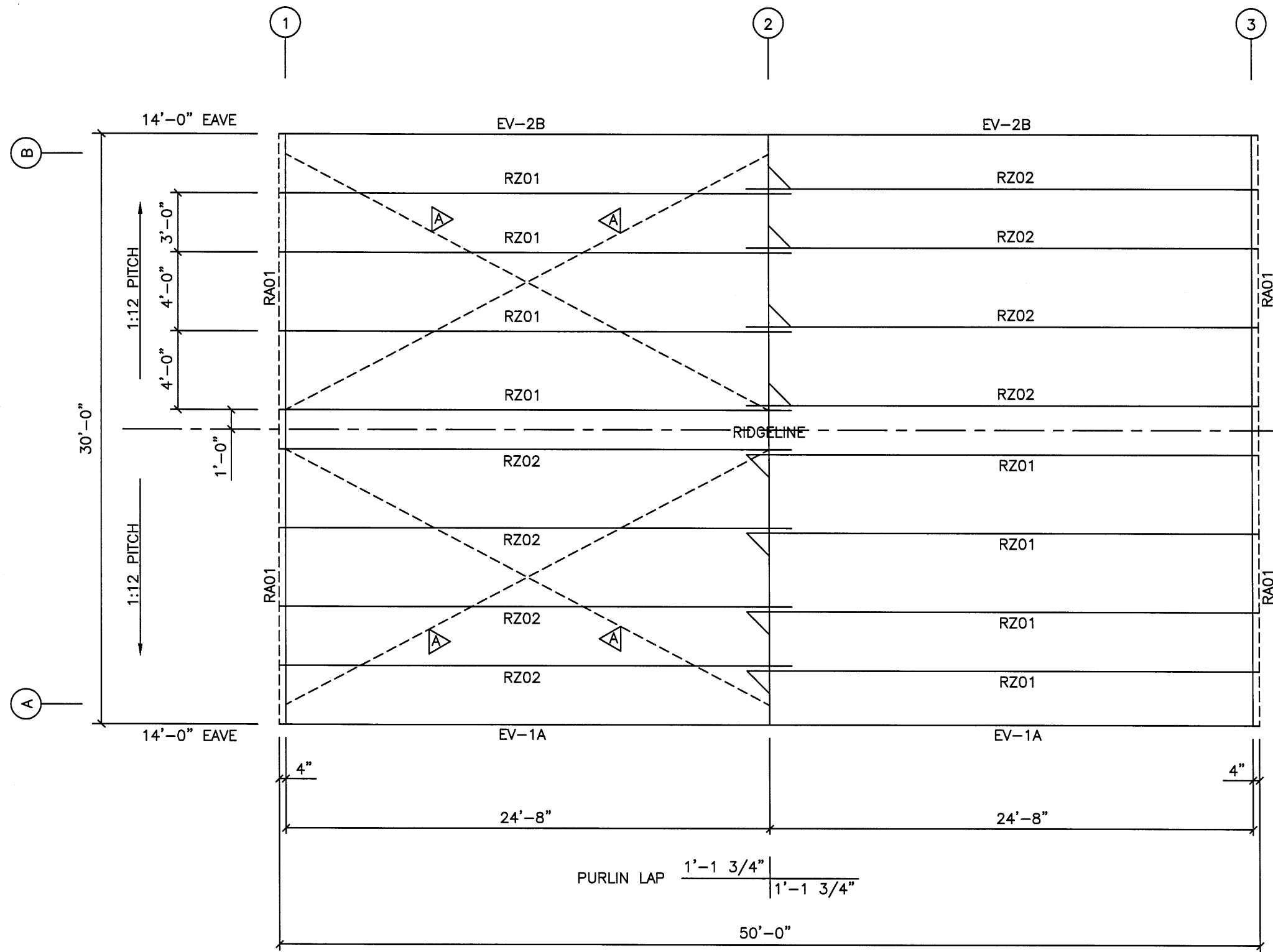

ROOF FRAMING PLAN
N.T.S.

E.H.S. CABLE BRACING



VALOR STEEL BUILDINGS
590 US HWY 98 - SUITE 3
DAPHNE, AL 36526
LOCAL (251) 379-8042
TOLL FREE (855) 55-VALOR
www.valorsteelbuildings.com

Bldg. Size: 30 x 50 x 14

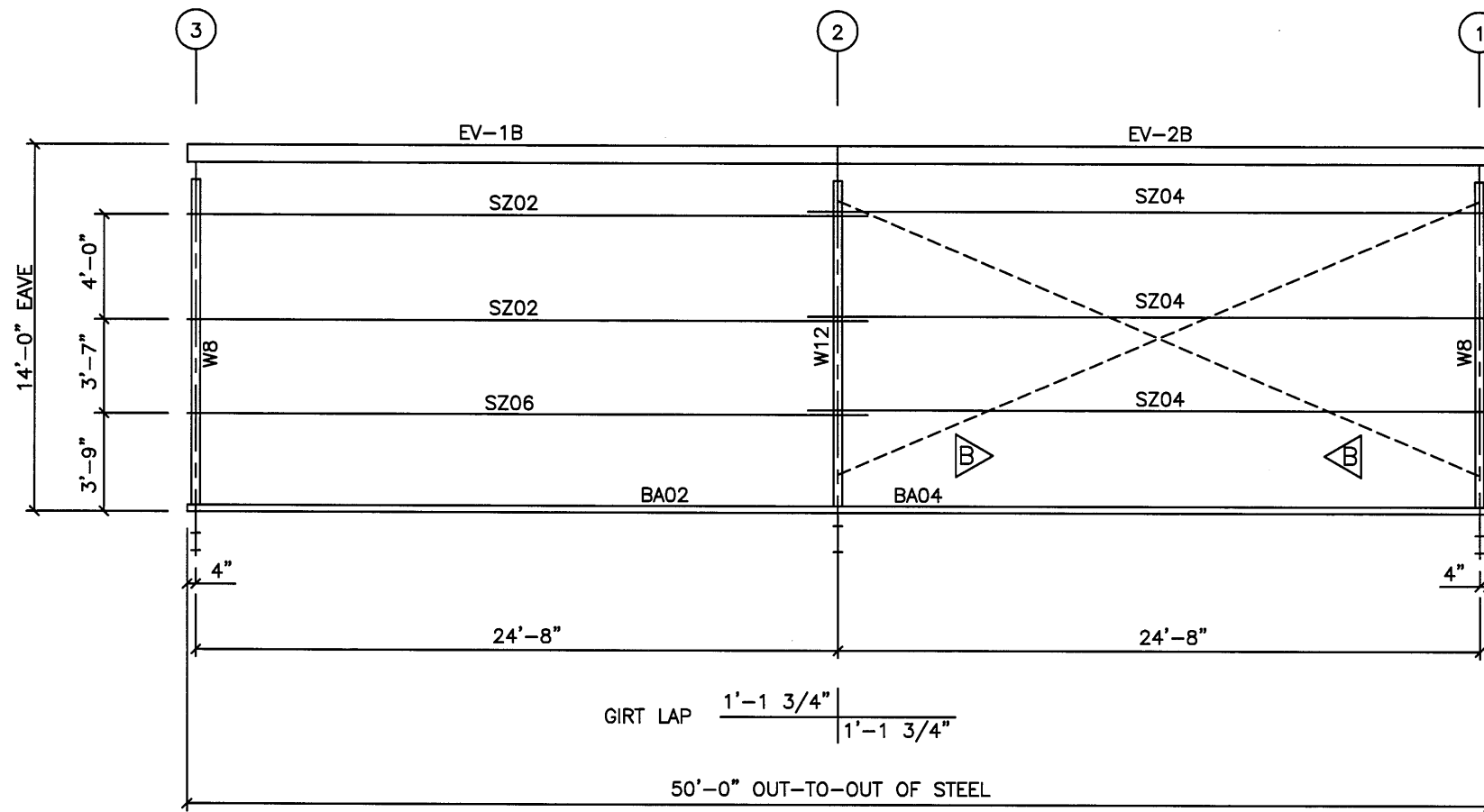

SIDEWALL FRAMING ELEV. @ COL. LINE B
N.T.S.

E.H.S. CABLE BRACING

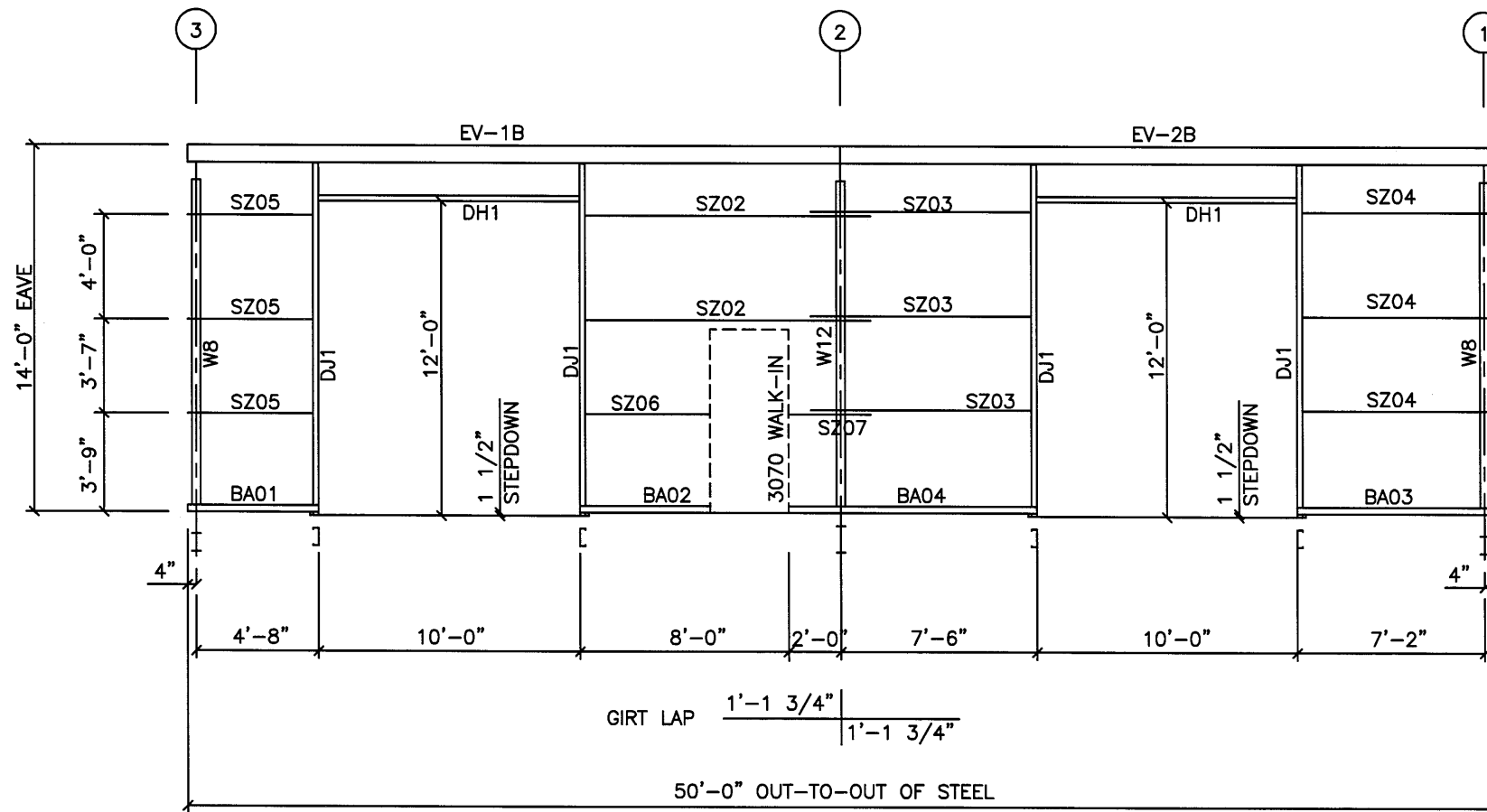

SIDEWALL FRAMING ELEV. @ COL. LINE B
N.T.S.

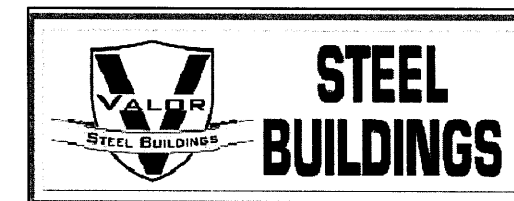

VALOR STEEL BUILDINGS
590 US HWY 98 - SUITE 3
DAPHNE, AL 36526
LOCAL (251) 379-8042
TOLL FREE (855) 55-VALOR
www.valorsteelbuildings.com

Bldg. Size: 30 x 50 x 14

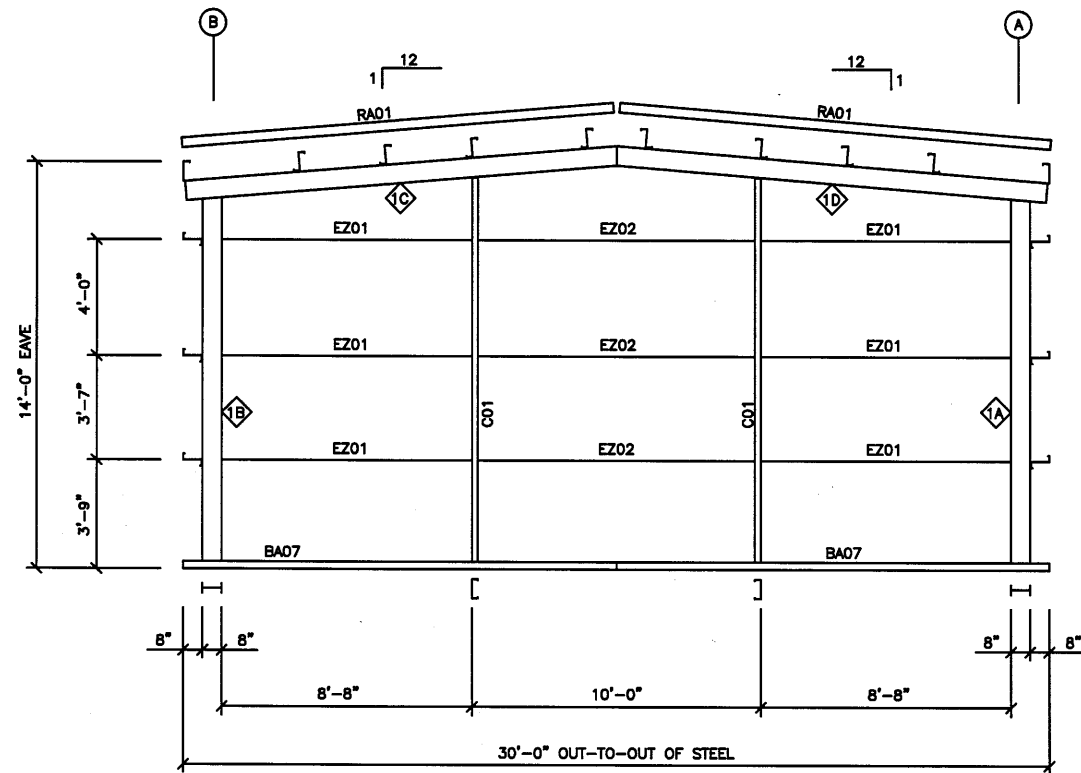

ENDWALL FRAMING ELEV. ● COL. LINE 1
N.T.S.

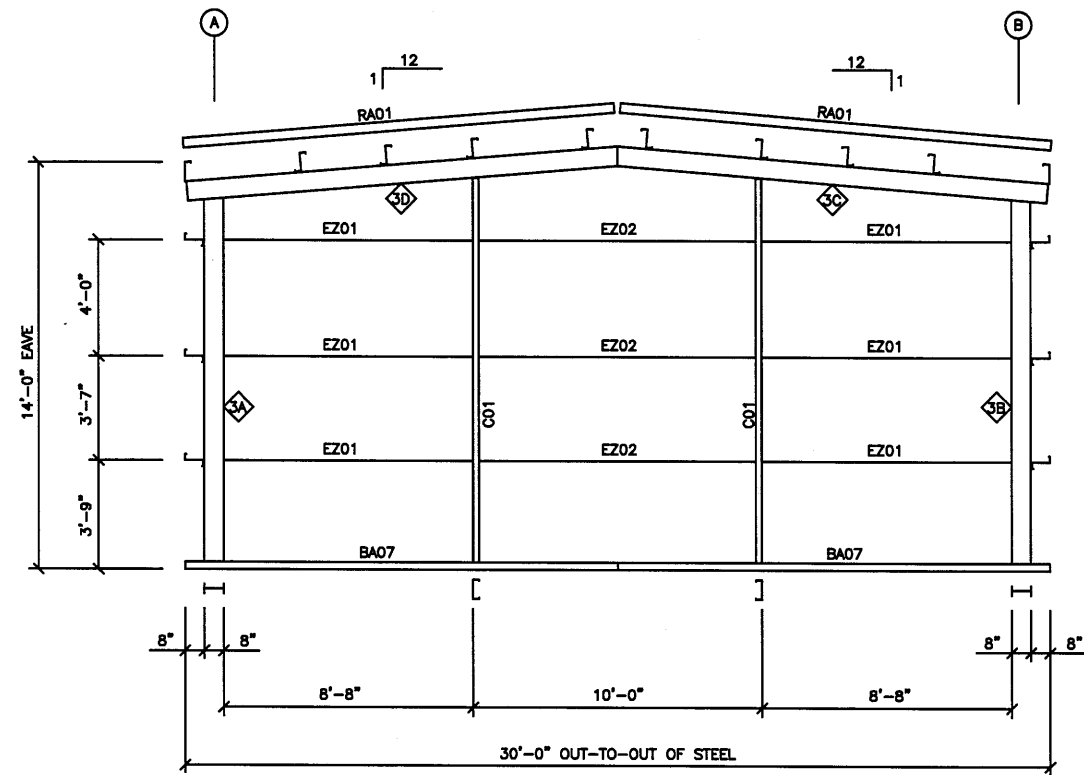

ENDWALL FRAMING ELEV. ● COL. LINE 3
N.T.S.

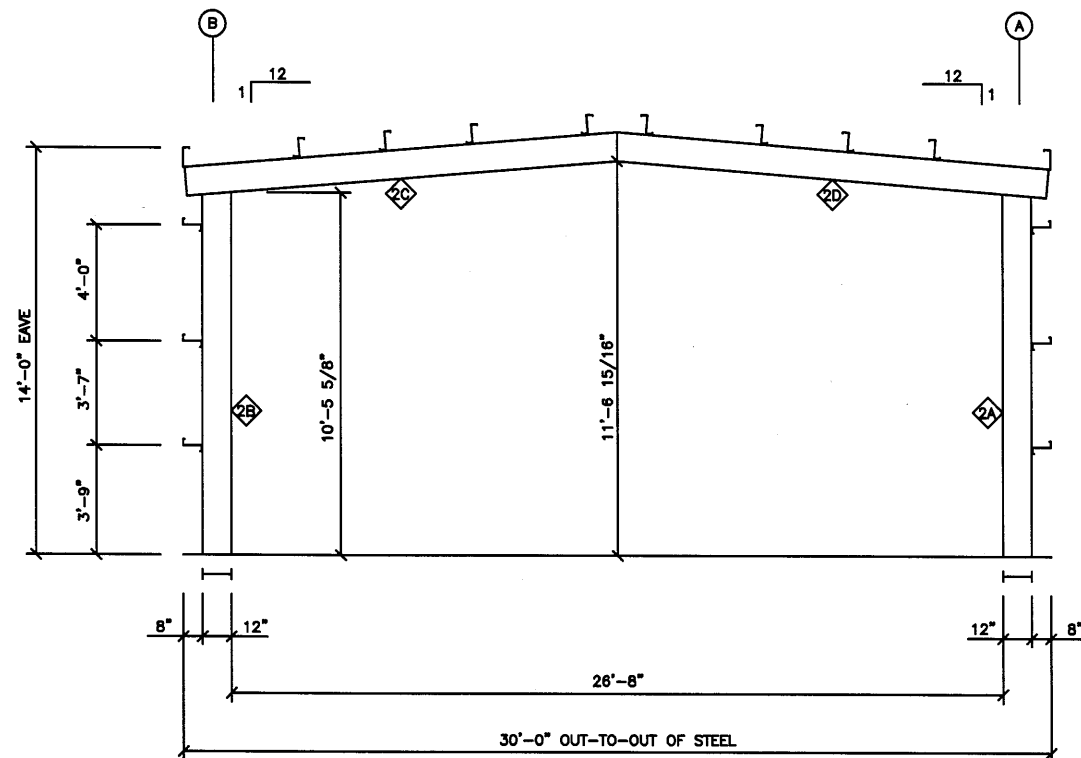
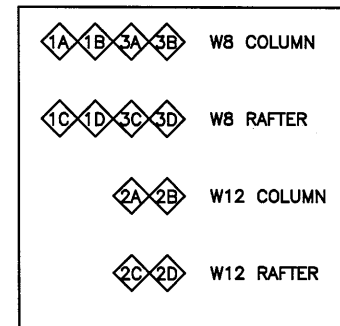

RIGID FRAMING ELEV. ● COL. LINE 2
N.T.S.

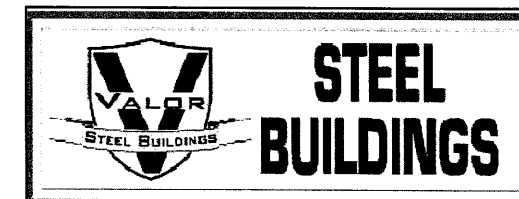

VALOR STEEL BUILDINGS
590 US HWY 98 - SUITE 3
DAPHNE, AL 36526
LOCAL (251) 379-8042
TOLL FREE (855) 55-VALOR
www.valorsteelbuildings.com

Bldg. Size: 30 x 50 x 14

1

3

B

RIDGECAPS

A

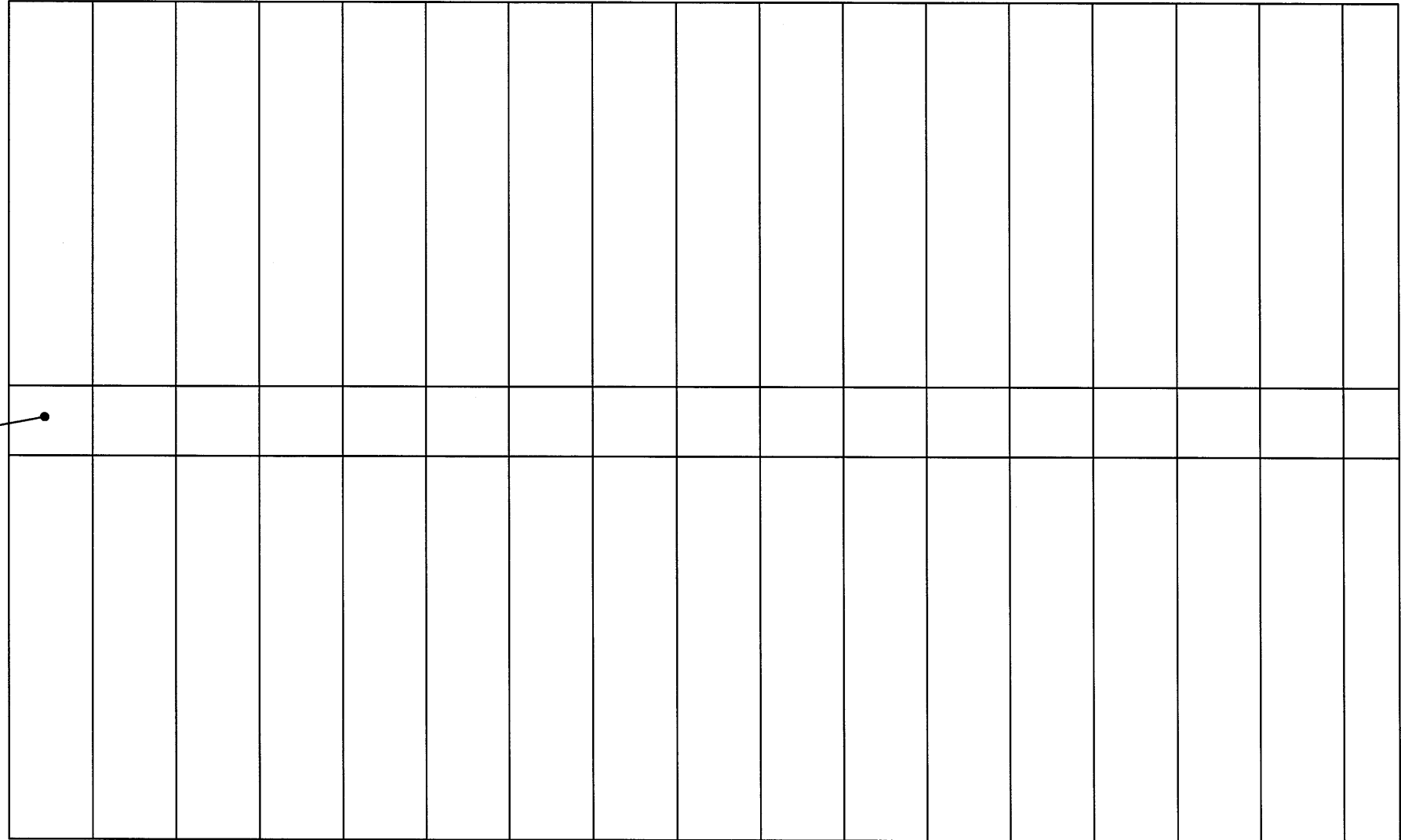

ROOF SHEETING PLAN
N.T.S.



VALOR STEEL BUILDINGS
 590 US HWY 98 - SUITE 3
 DAPHNE, AL 36526
 LOCAL (251) 379-8042
 TOLL FREE (855) 55-VALOR
www.valorsteelbuildings.com

Bldg. Size: 30 x 50 x 14

Sht. SH1 of 3

1

3

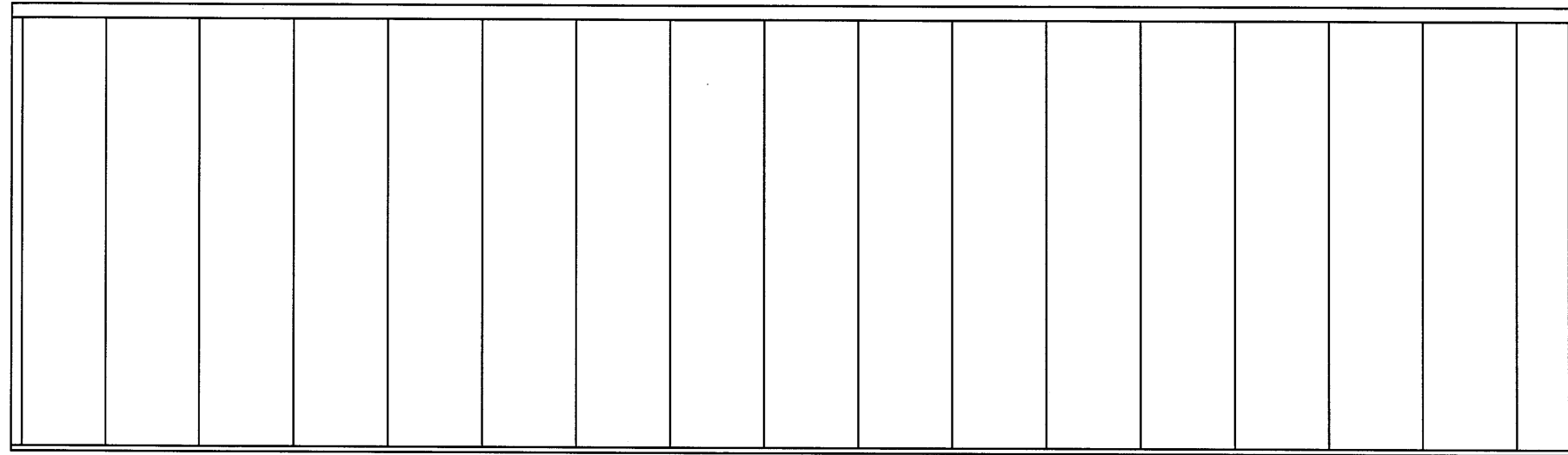

SIDEWALL SHEETED ELEV. @ COL. LINE A
N.T.S.

3

1

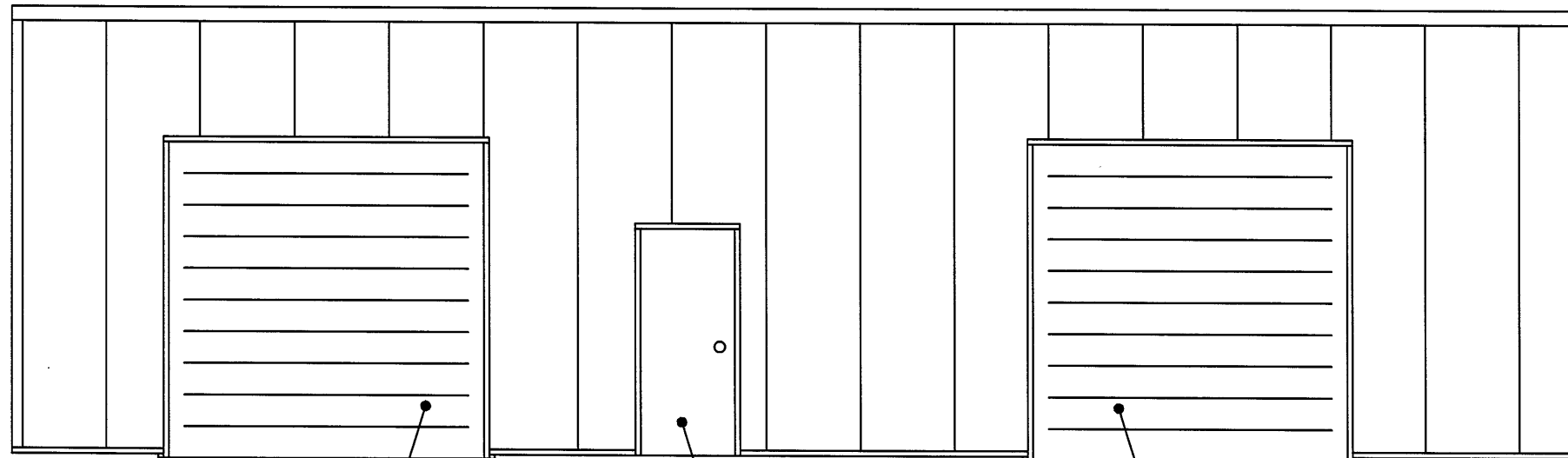

10 x 10 ROLL-UP DOOR

3070 WALK-IN DOOR

10 x 10 ROLL-UP DOOR

SIDEWALL SHEETED ELEV. @ COL. LINE B
N.T.S.

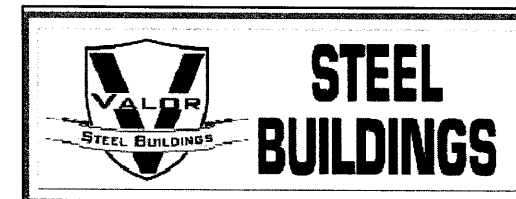

VALOR STEEL BUILDINGS
590 US HWY 98 - SUITE 3
DAPHNE, AL 36526
LOCAL (251) 379-8042
TOLL FREE (855) 55-VALOR
www.valorsteelbuildings.com

Bldg. Size: 30 x 50 x 14

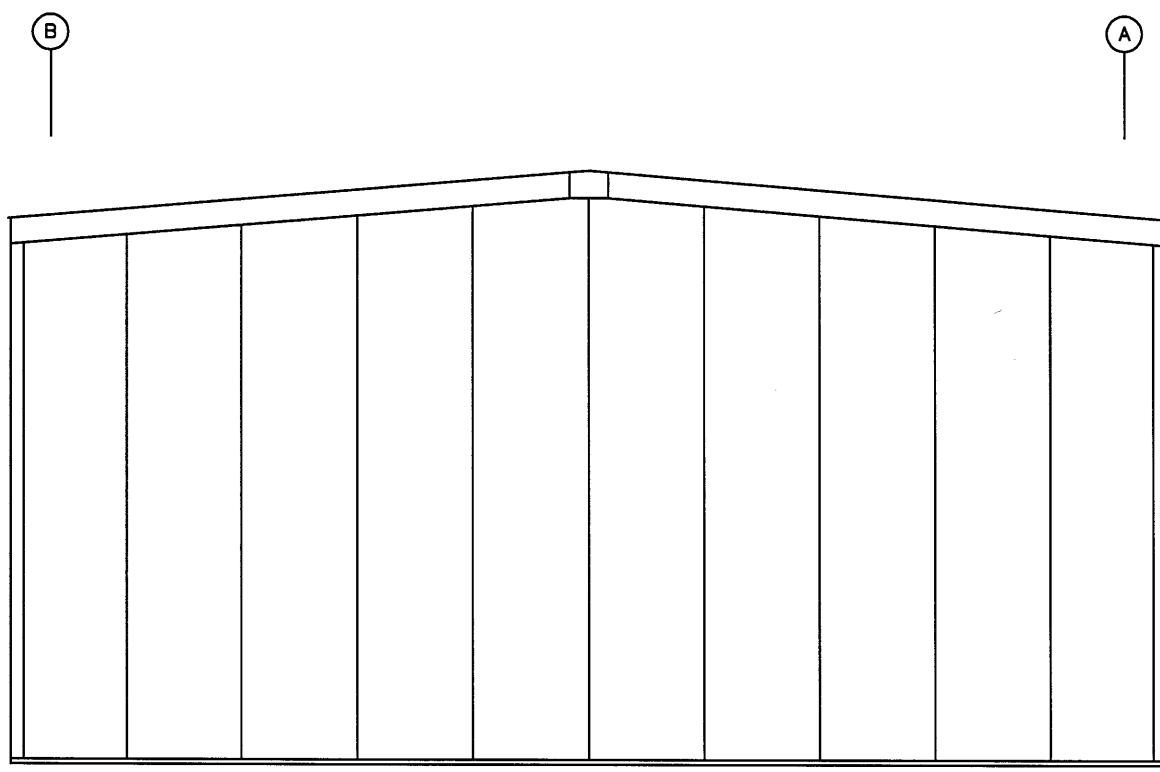

ENDWALL SHEETED ELEV. @ COL. LINE 1
N.T.S.

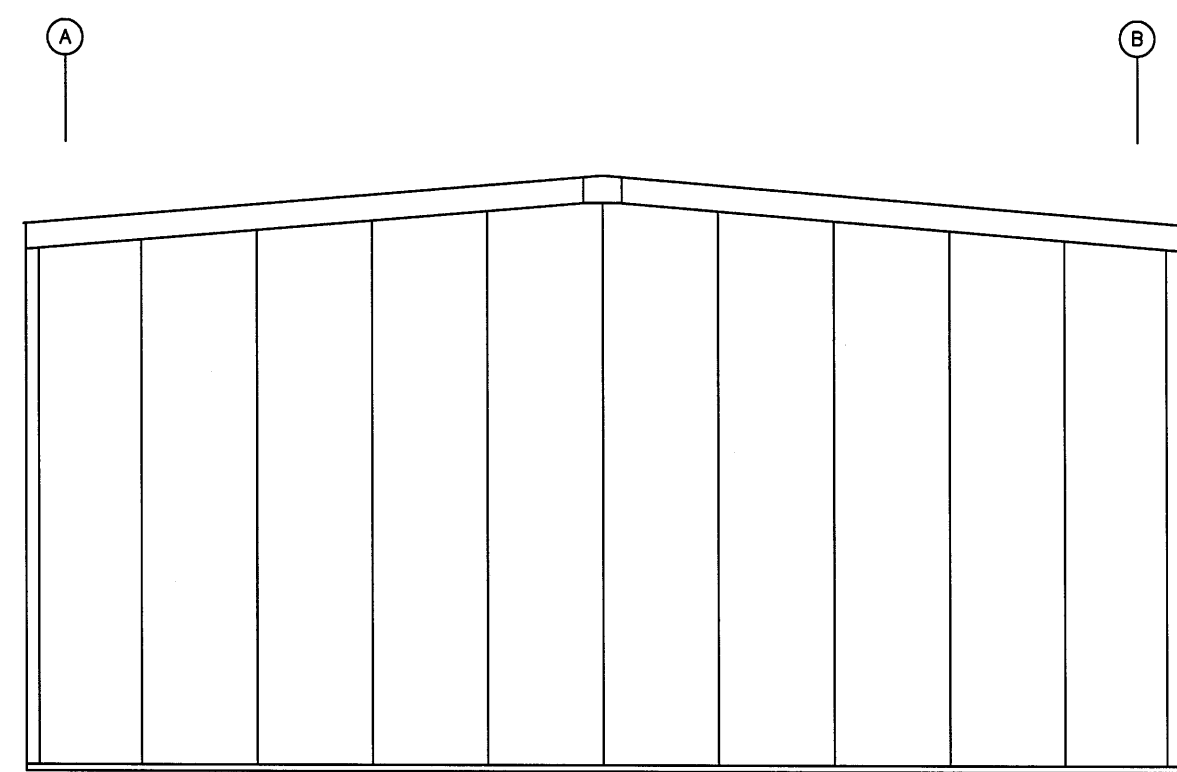

ENDWALL SHEETED ELEV. @ COL. LINE 3
N.T.S.



VALOR STEEL BUILDINGS
590 US HWY 98 - SUITE 3
DAPHNE, AL 36526
LOCAL (251) 379-8042
TOLL FREE (855) 55-VALOR
www.valorsteelbuildings.com

Bldg. Size: 30 x 50 x 14

Sht. SH3of3