

BLDG. SIZE: 40 x 50 x 12
(3:12 PITCH)

AB2 of 2 — Anchor Bolt Plan
F1 of 1 — Foundation Plan
F2 of 2 — Footer Sections
1 of 3 — Roof Framing Plan
2 of 3 — Sidewall Framing Elev.
3 of 3 — Endwall & Rigid Framing Elev.
SH1 of 3 — Roof Sheeting Plan
SH2 of 3 — Sidewall Sheeting Elev.
SH3 of 3 — Endwall Sheeting Elev.

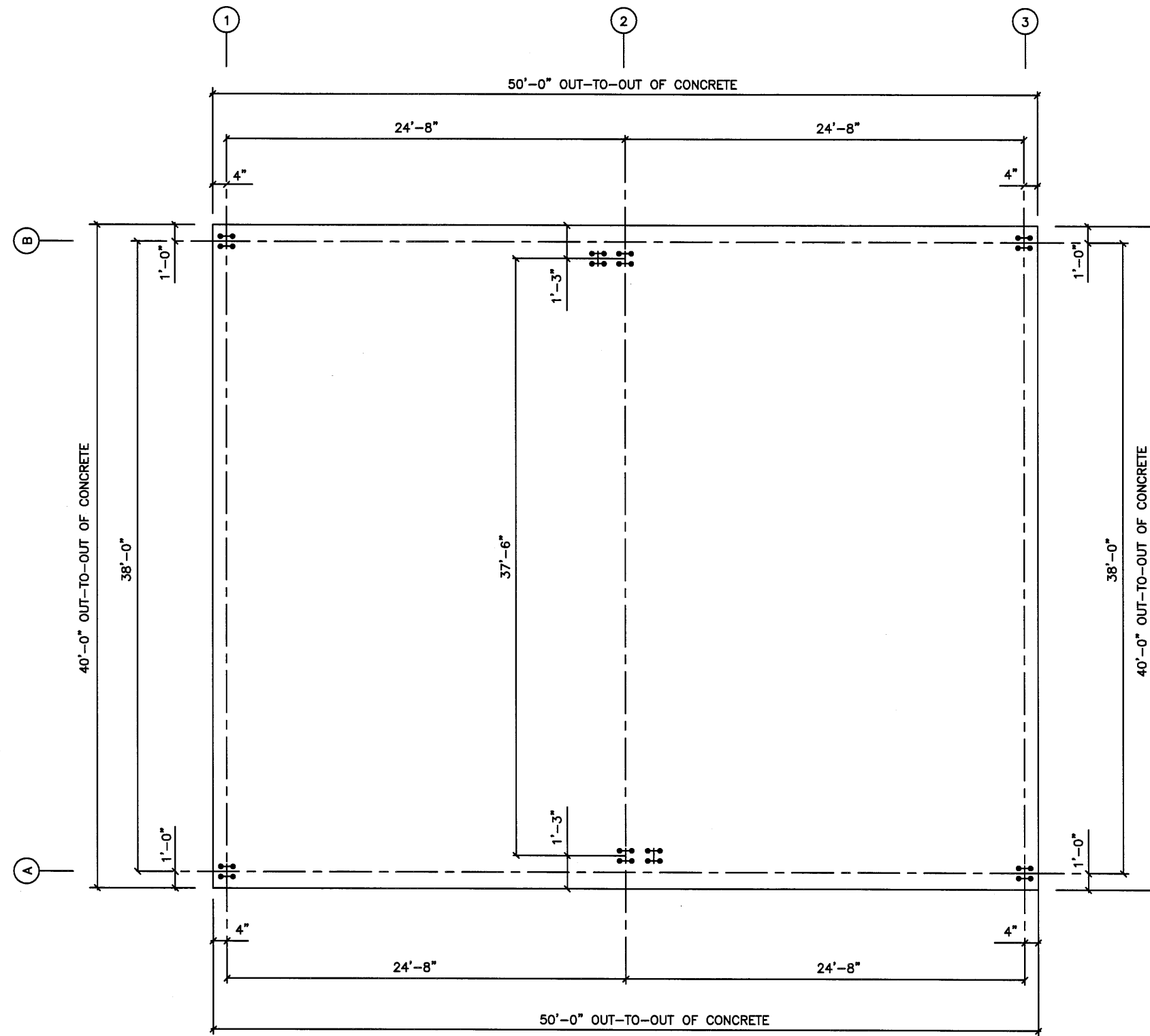

590 US HWY 98
SUITE 3
DAPHNE, AL 36526
LOCAL (251) 379-8042
TOLL FREE (855) 55-VALOR
www.valorsteelbuildings.com



ANCHOR BOLT PLAN
N.T.S.

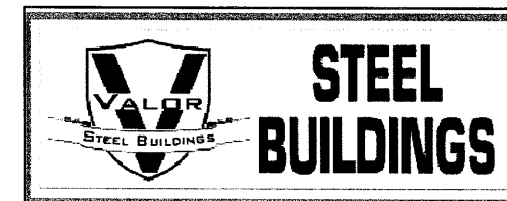

**STEEL
BUILDINGS**

VALOR STEEL BUILDINGS
590 US HWY 98 - SUITE 3
DAPHNE, AL 36526
LOCAL (251) 379-8042
TOLL FREE (855) 55-VALOR
www.valorsteelbuildings.com

Bldg. Size: 40 x 50 x 12

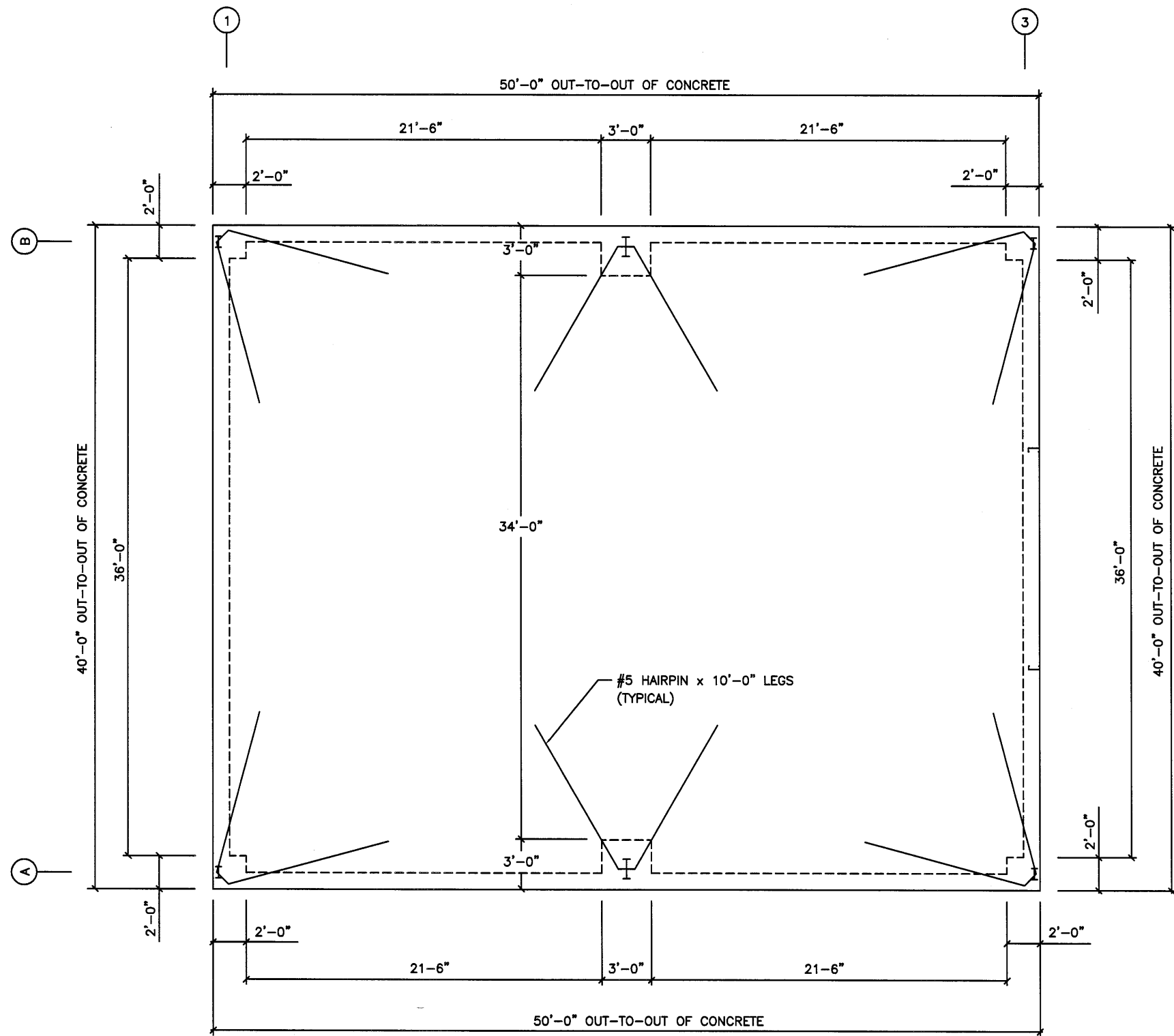

FOUNDATION PLAN
N.T.S.

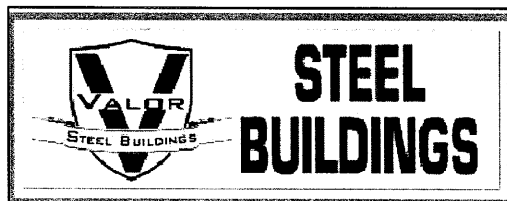

STEEL BUILDINGS

VALOR STEEL BUILDINGS
590 US HWY 98 - SUITE 3
DAPHNE, AL 36526
LOCAL (251) 379-8042
TOLL FREE (855) 55-VALOR
www.valorsteelbuildings.com

Bldg. Size: 40 x 50 x 12

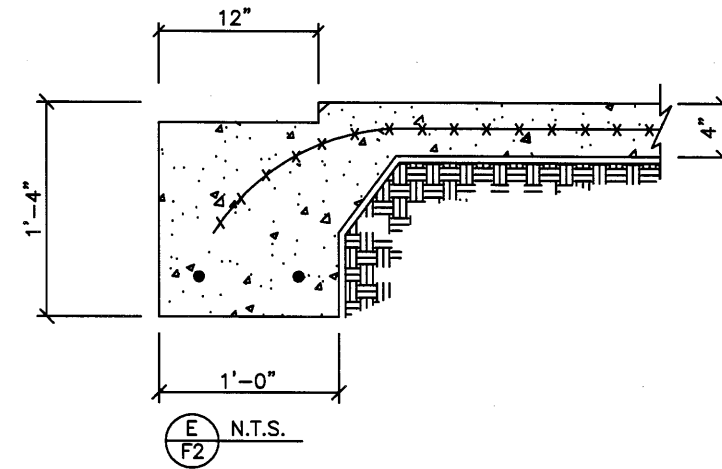
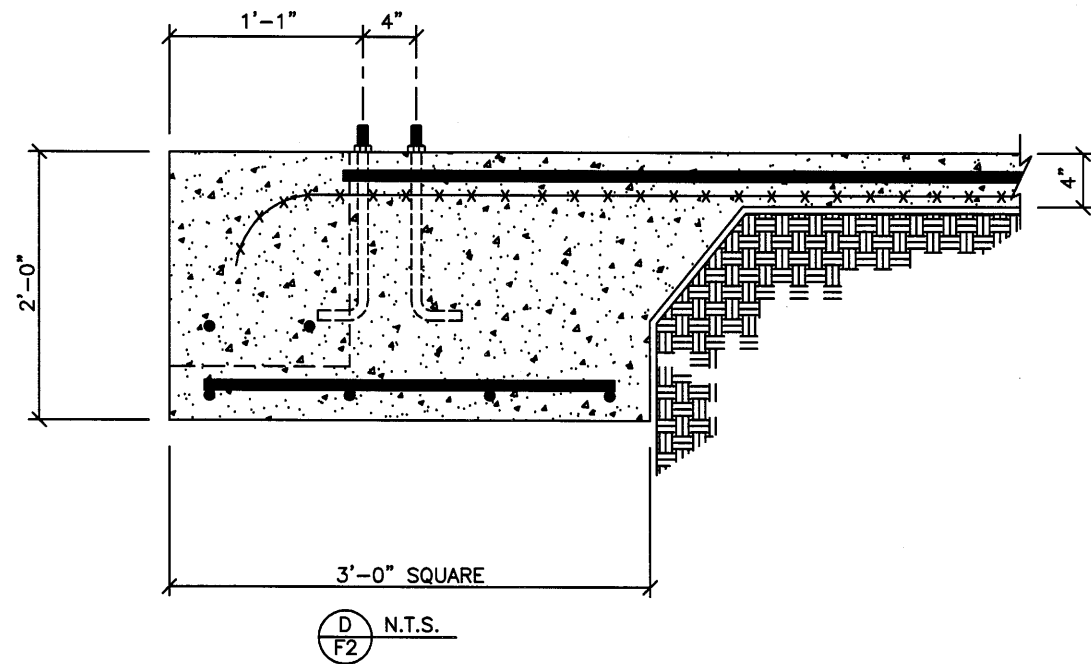
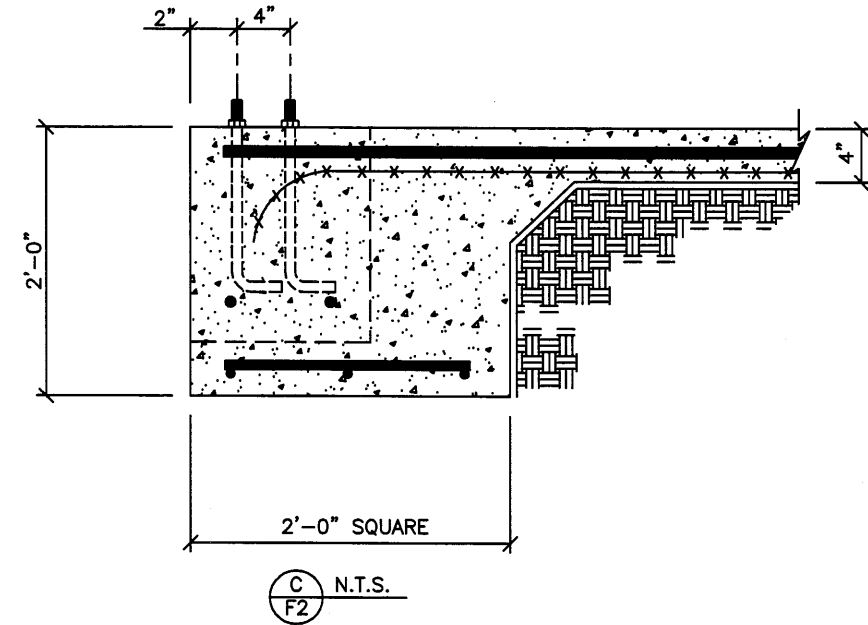
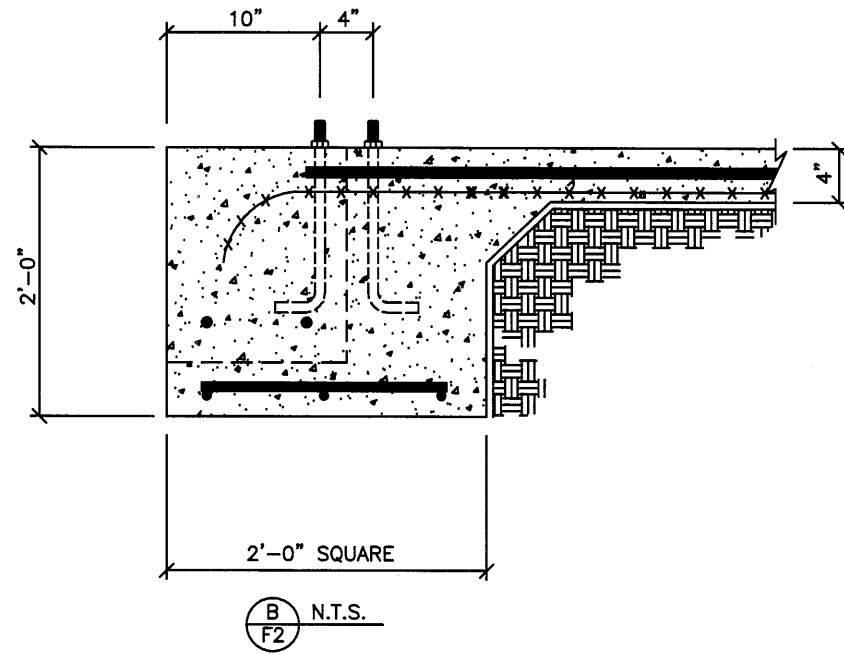
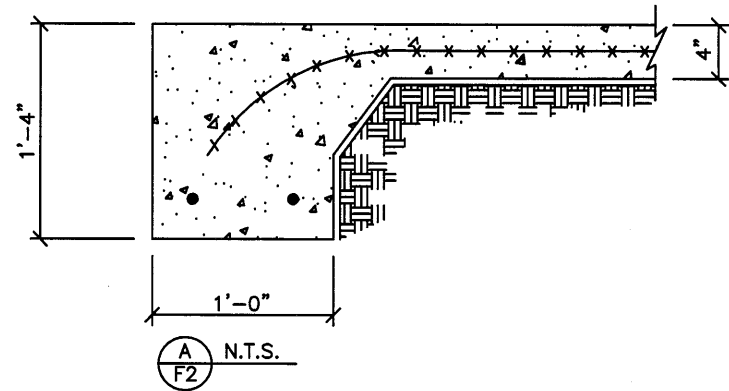

STEEL BUILDINGS

VALOR STEEL BUILDINGS
 590 US HWY 98 - SUITE 3
 DAPHNE, AL 36526
 LOCAL (251) 379-8042
 TOLL FREE (855) 55-VALOR
www.valorsteelbuildings.com

Bldg. Size: 40 x 50 x 12

Sht. F2of2

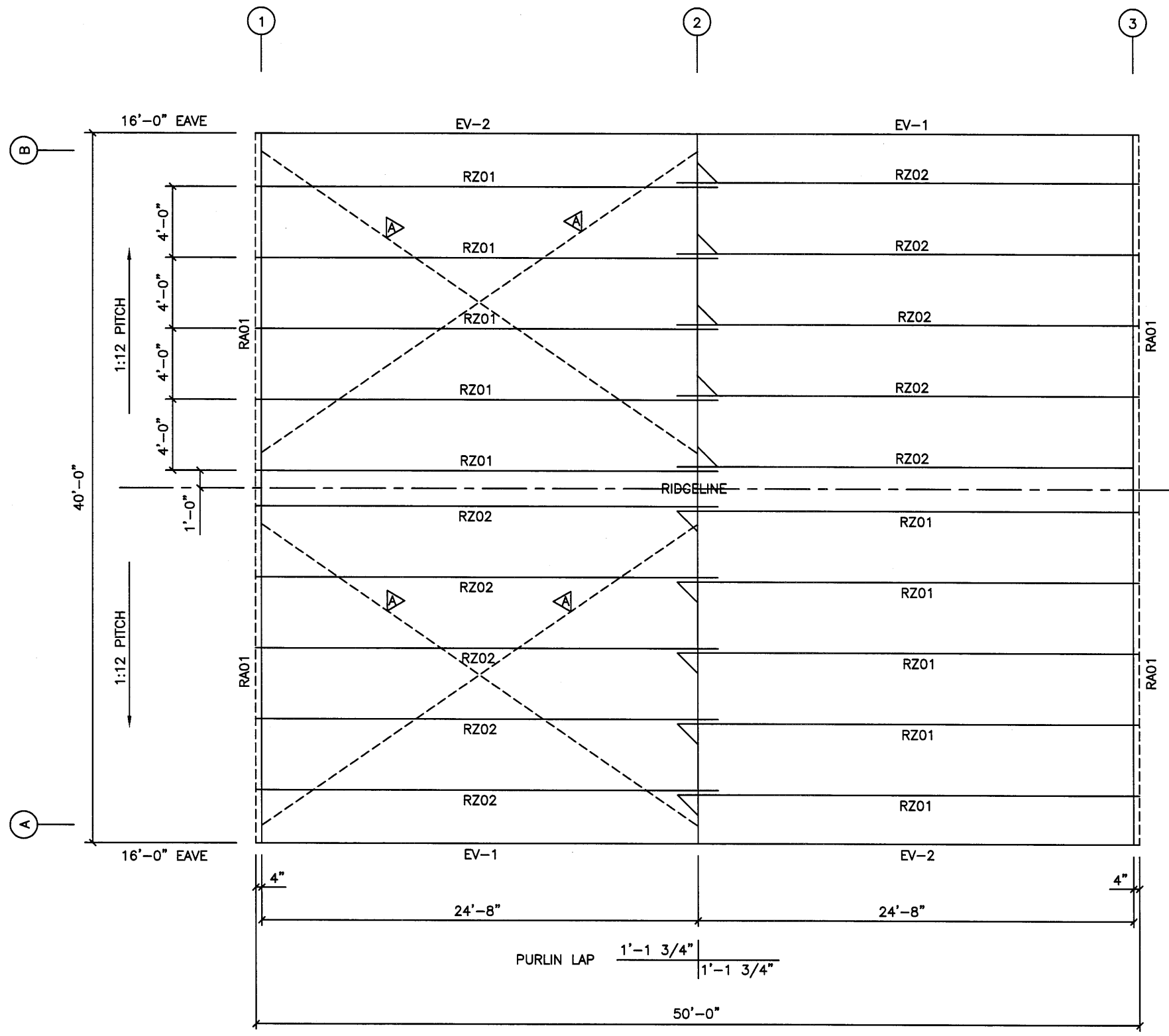

ROOF FRAMING PLAN
N.T.S.



STEEL BUILDINGS

VALOR STEEL BUILDINGS
590 US HWY 98 - SUITE 3
DAPHNE, AL 36526
LOCAL (251) 379-8042
TOLL FREE (855) 55-VALOR
www.valorsteelbuildings.com

Bldg. Size: 40 x 50 x 12

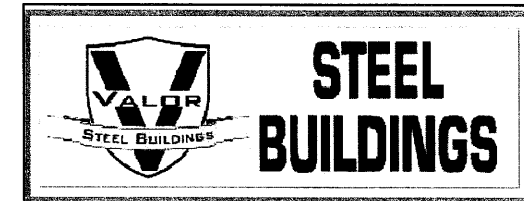
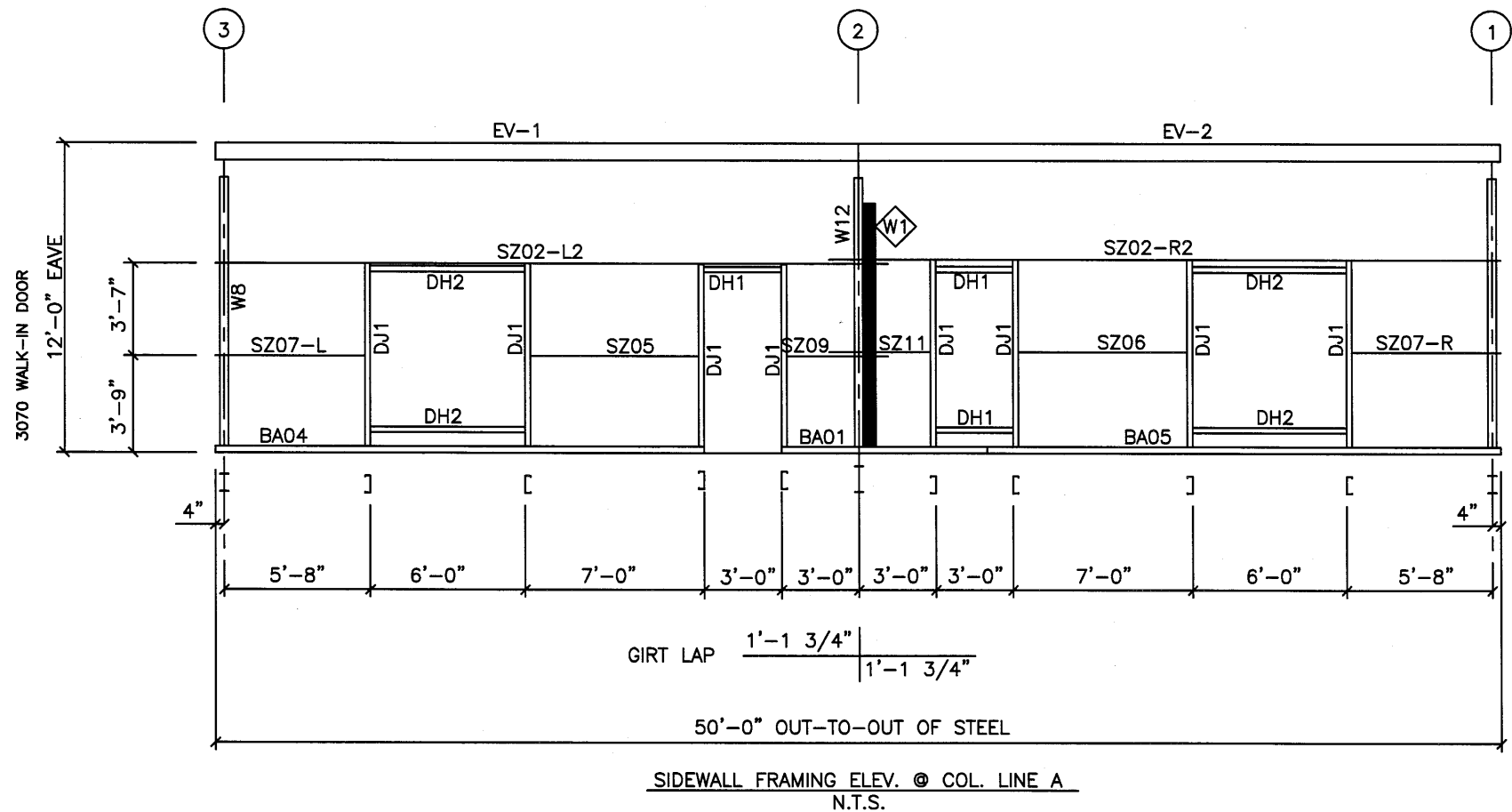
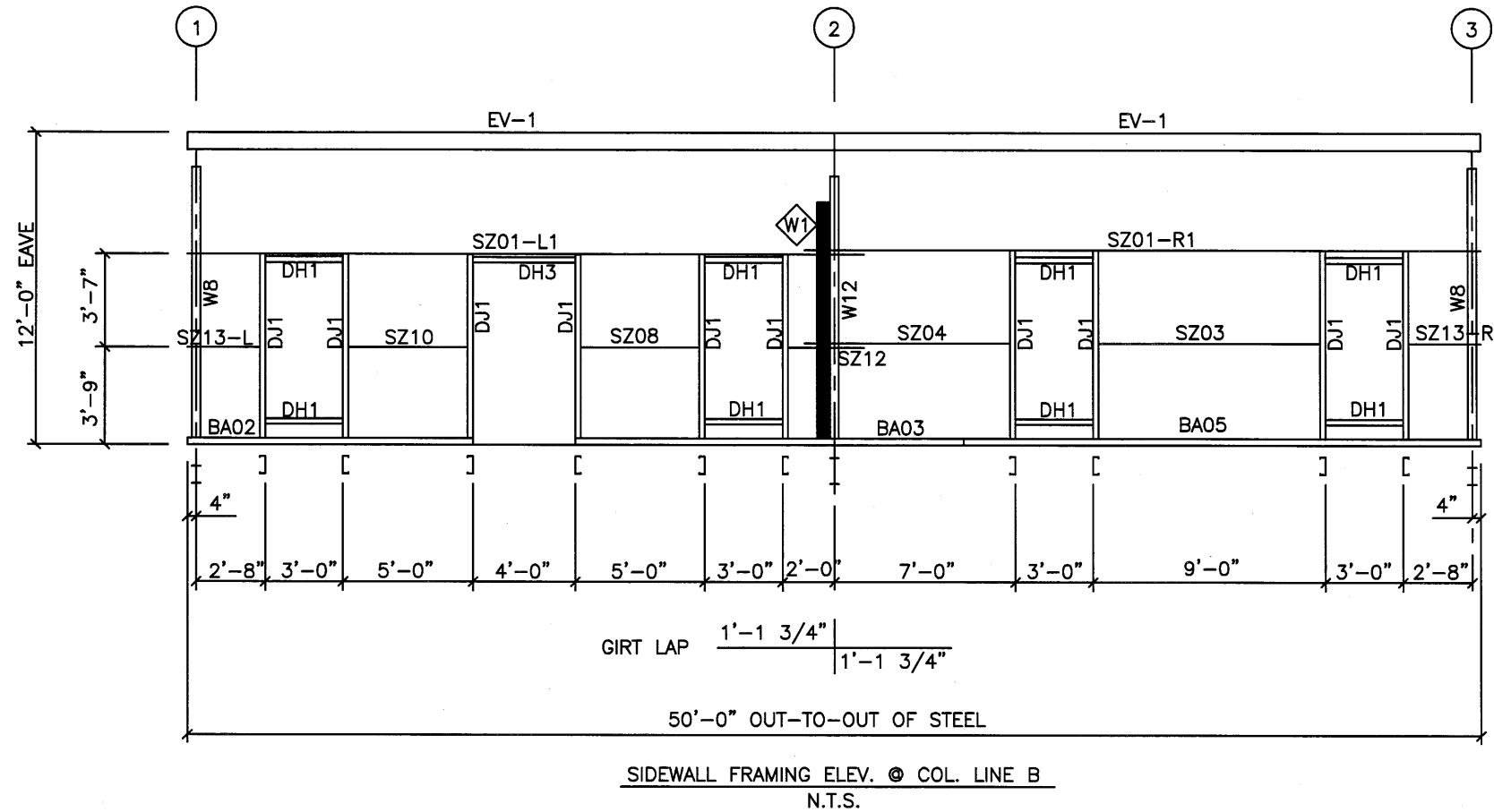

VALOR STEEL BUILDINGS
 590 US HWY 98 - SUITE 3
 DAPHNE, AL 36526
 LOCAL (251) 379-8042
 TOLL FREE (855) 55-VALOR
www.valorsteelbuildings.com

Bldg. Size: 40 x 50 x 12

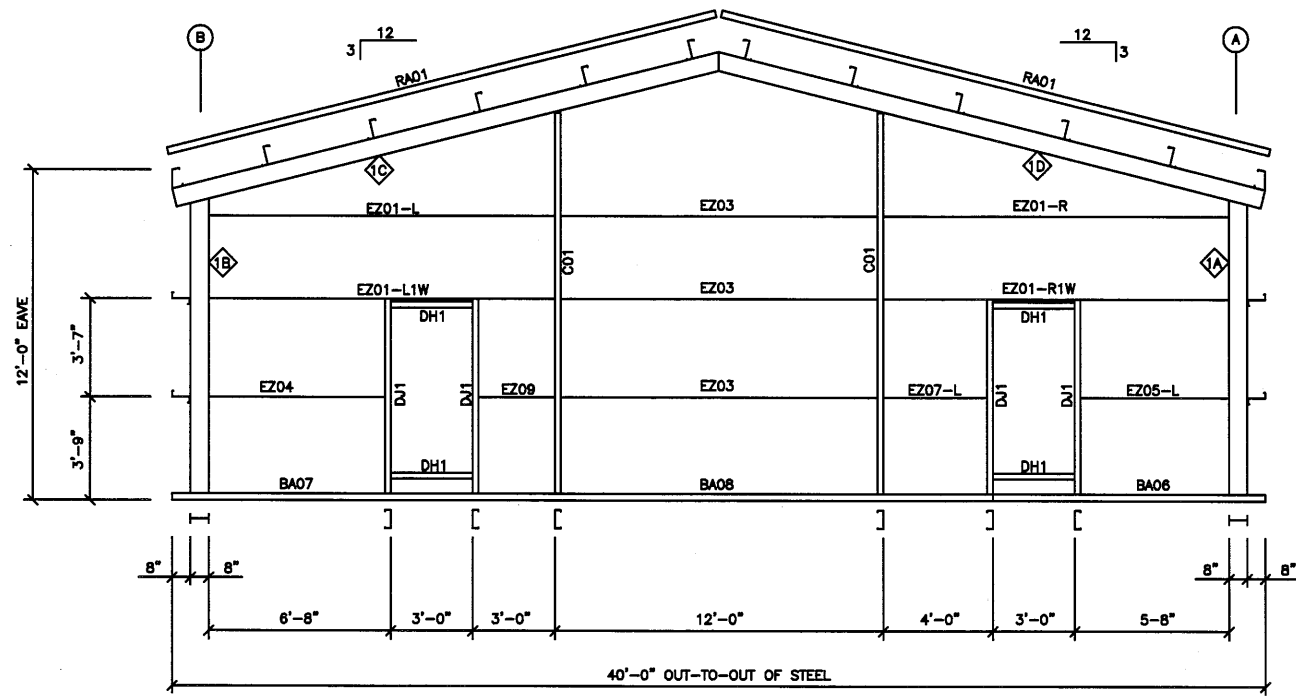

ENDWALL FRAMING ELEV. @ COL. LINE 1
N.T.S.

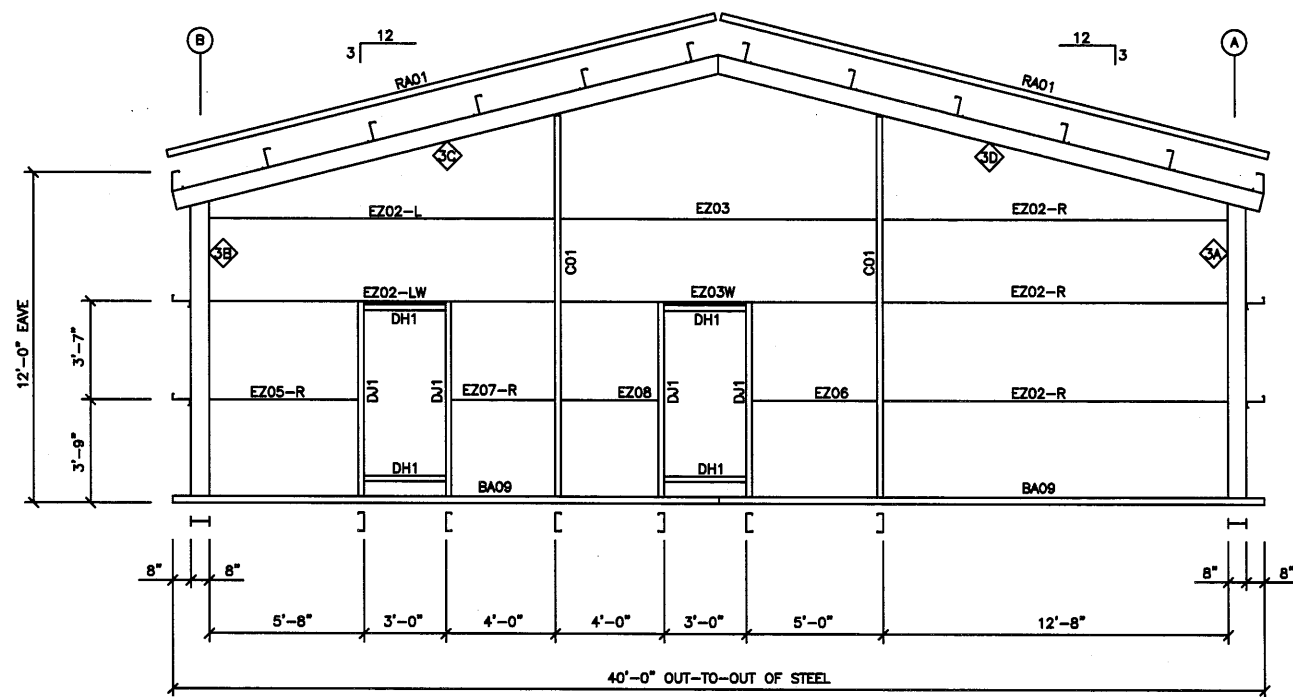

ENDWALL FRAMING ELEV. @ COL. LINE 3
N.T.S.

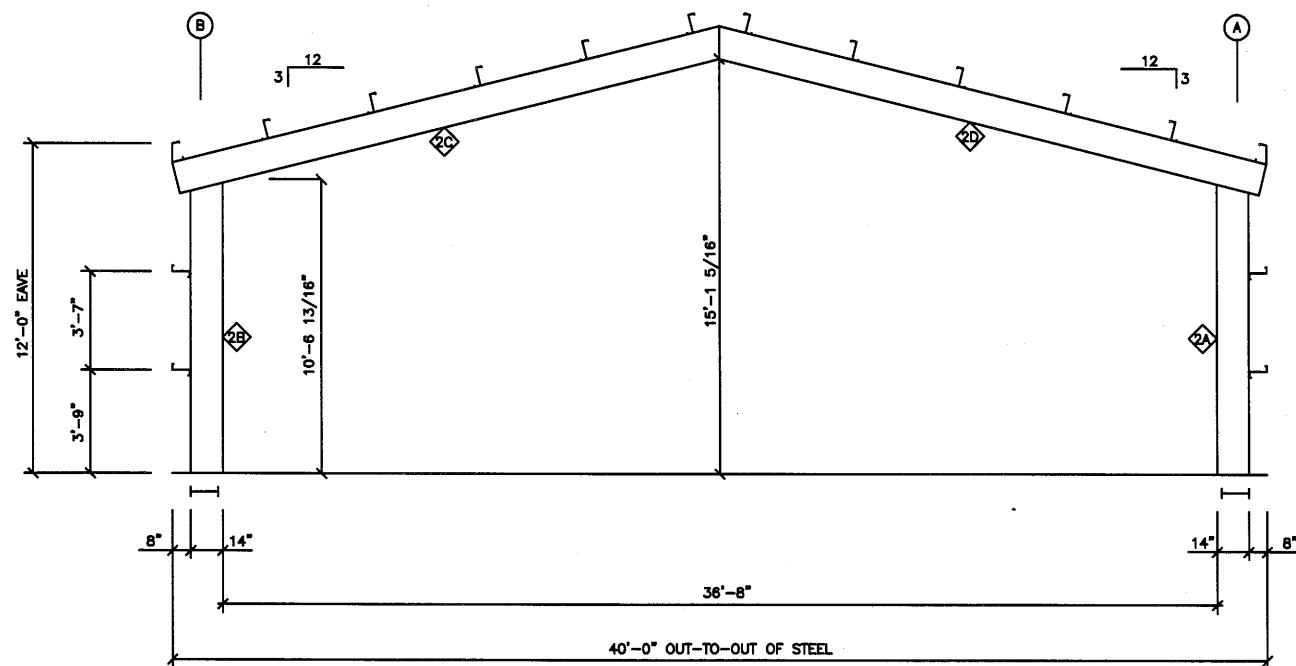

RIGID FRAMING ELEV. @ COL. LINE 2
N.T.S.

1A 1B 3A 3B	WB COLUMN
1C 1D 3C 3D	WB RAFTER
2A 2B	W14 COLUMN
2C 2D	W14 RAFTER

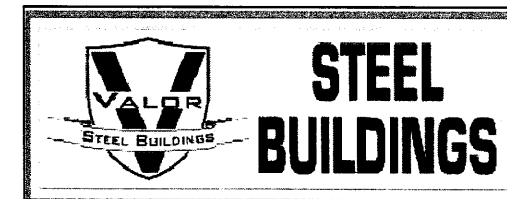

STEEL BUILDINGS

VALOR STEEL BUILDINGS
590 US HWY 98 - SUITE 3
DAPHNE, AL 36526
LOCAL (251) 379-8042
TOLL FREE (855) 55-VALOR
www.valorsteelbuildings.com

Bldg. Size: 40 x 50 x 12

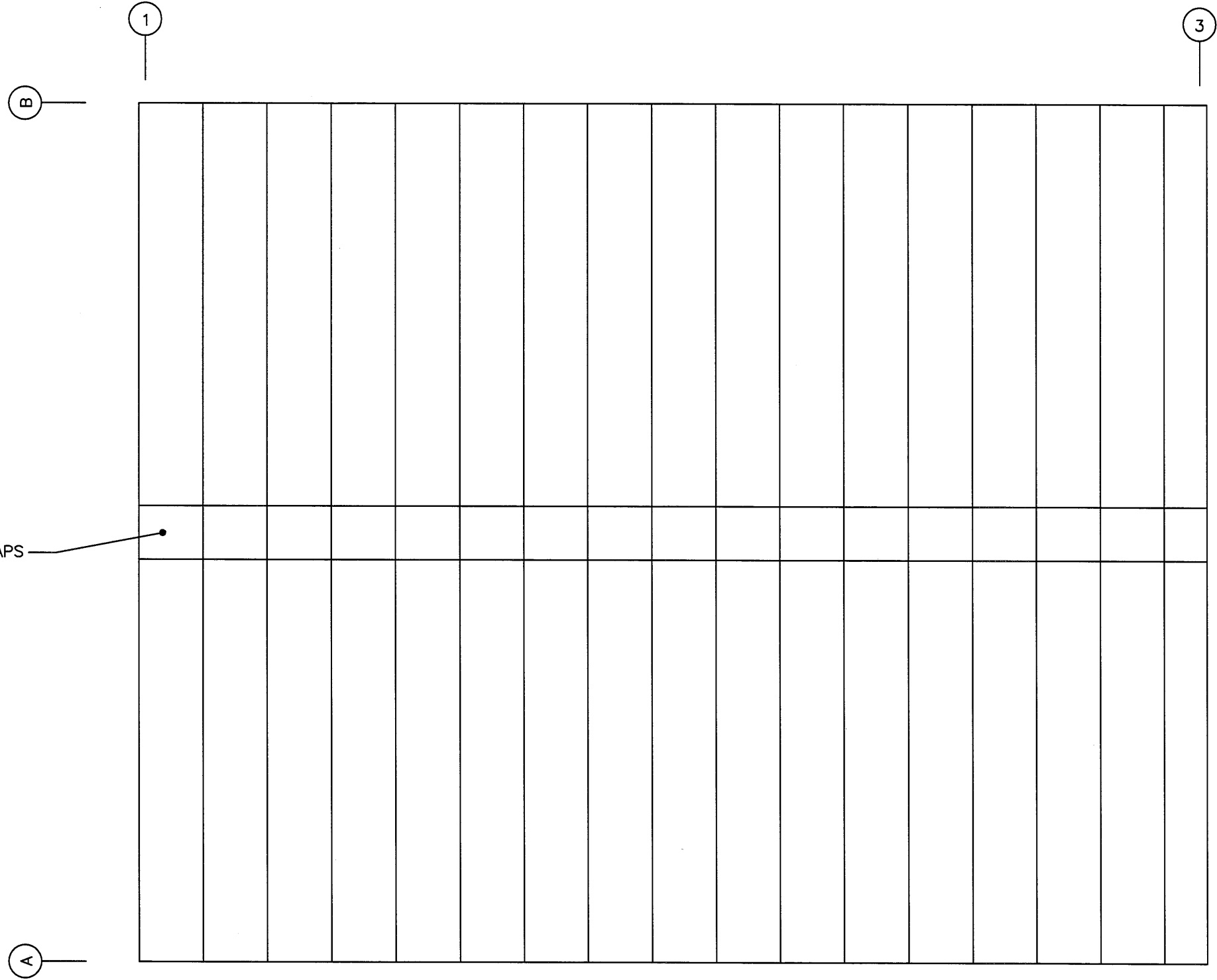

ROOF SHEETING PLAN
N.T.S.

 <p>STEEL BUILDINGS</p>	<p>VALOR STEEL BUILDINGS 590 US HWY 98 - SUITE 3 DAPHNE, AL 36526 LOCAL (251) 379-8042 TOLL FREE (855) 55-VALOR www.valorsteelbuildings.com</p>
---	--

Bldg. Size: 40 x 50 x 12

1

3

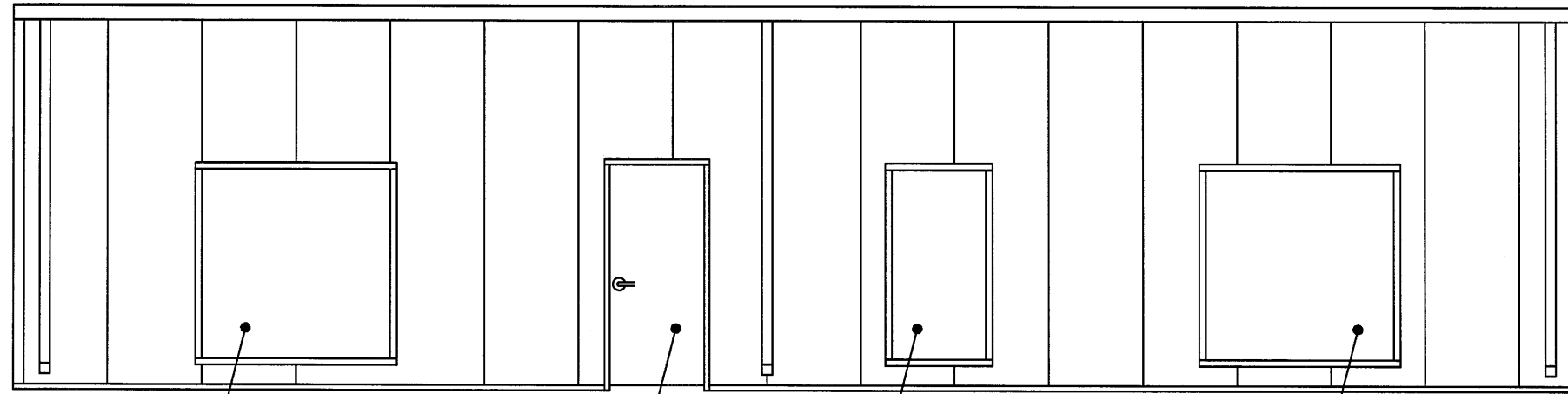

6 x 6 F.O.

3070 WALK-IN DOOR

3 x 6 F.O.

6 x 6 F.O.

SIDEWALL SHEETED ELEV. @ COL. LINE A
N.T.S.

3

1

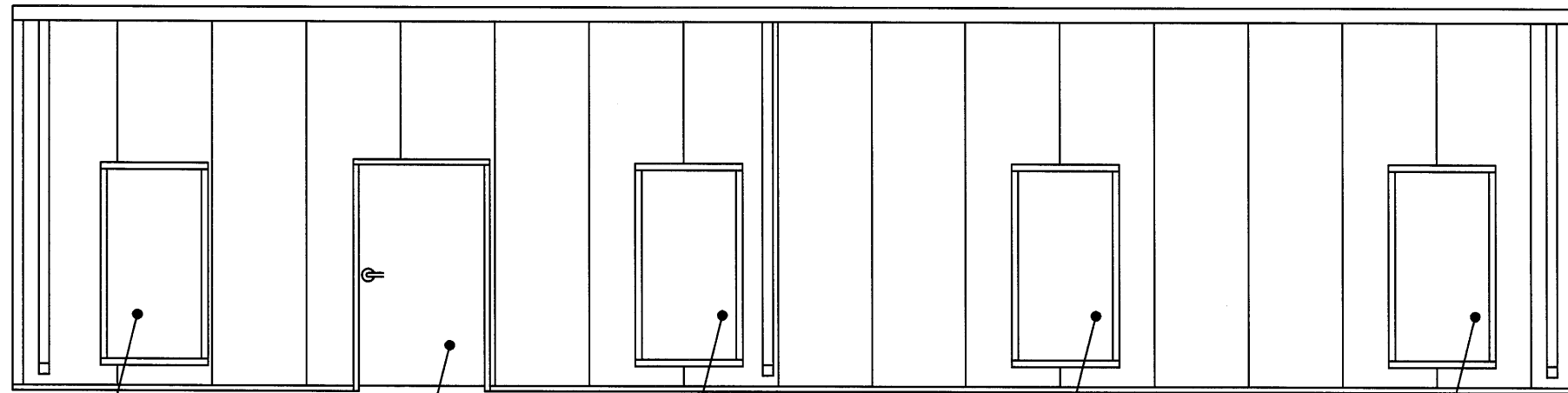

3 x 6 F.O.

4070 WALK-IN DOOR

3 x 6 F.O.

3 x 6 F.O.

3 x 6 F.O.

SIDEWALL SHEETED ELEV. @ COL. LINE B
N.T.S.

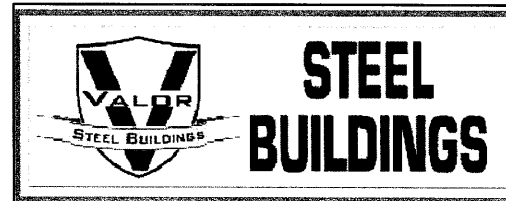

STEEL BUILDINGS

VALOR STEEL BUILDINGS
590 US HWY 98 - SUITE 3
DAPHNE, AL 36526
LOCAL (251) 379-8042
TOLL FREE (855) 55-VALOR
www.valorsteelbuildings.com

Bldg. Size: 40 x 50 x 12

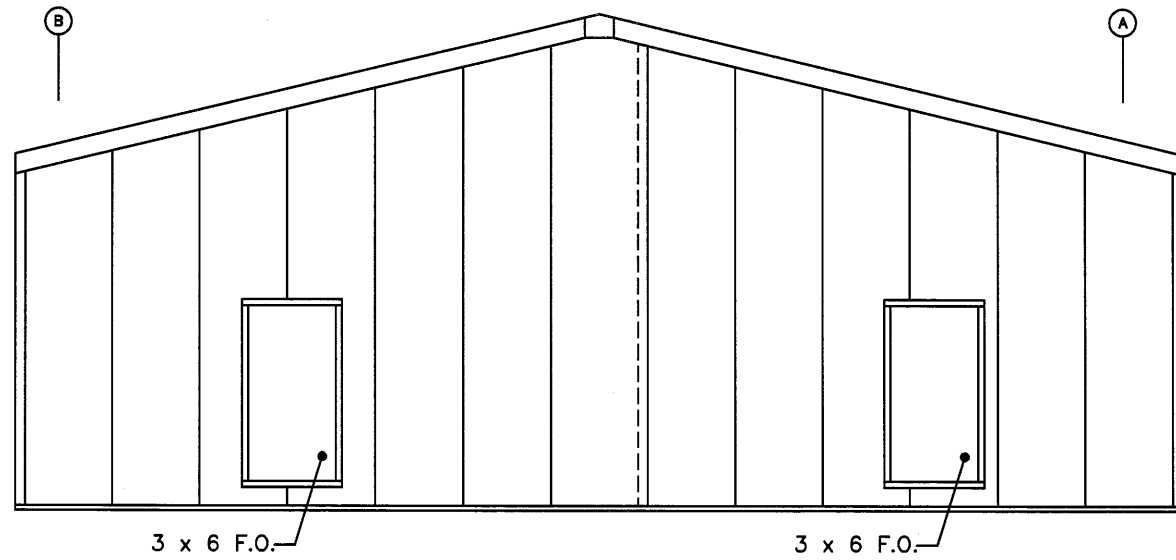

ENDWALL SHEETED ELEV. @ COL. LINE 1
N.T.S.

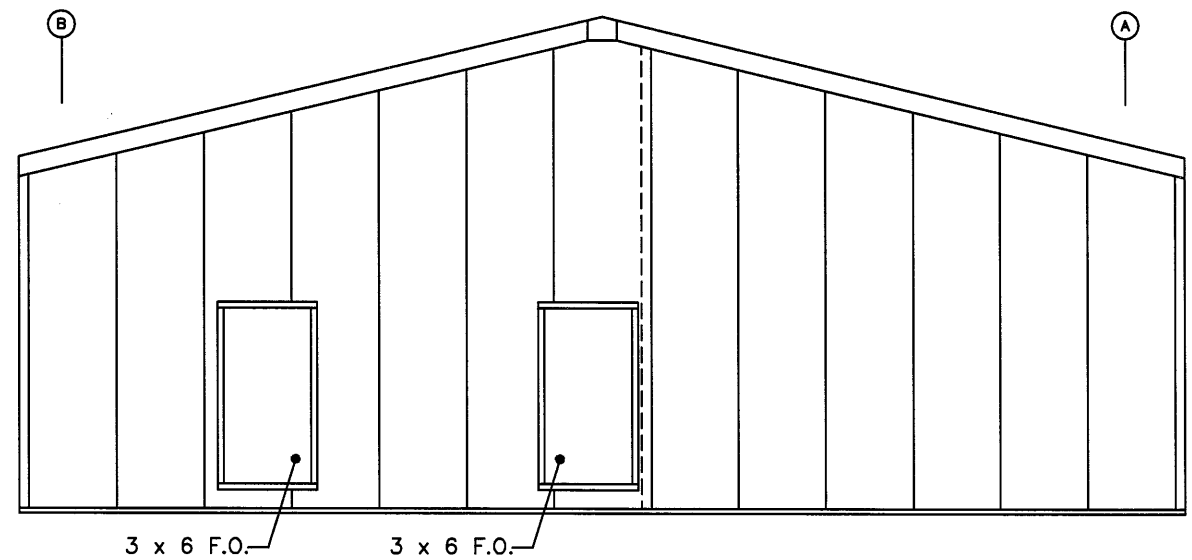

ENDWALL SHEETED ELEV. @ COL. LINE 3
N.T.S.

 <p>STEEL BUILDINGS</p>	<p>VALOR STEEL BUILDINGS 590 US HWY 98 - SUITE 3 DAPHNE, AL 36526 LOCAL (251) 379-8042 TOLL FREE (855) 55-VALOR www.valorsteelbuildings.com</p>
---	--

Bldg. Size: 40 x 50 x 12